



Rodamientos autoalineables y soportes

Programa estándar



Información Técnica de Producto TPI 106

Rodamientos autoalineables con soportes de fundición – Programa estándar

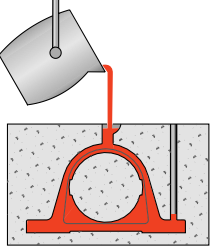
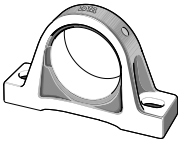
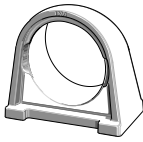
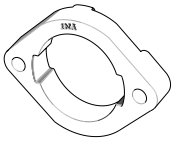
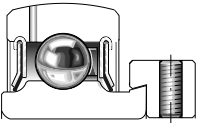
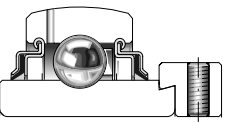
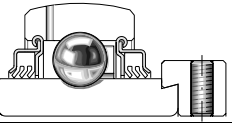
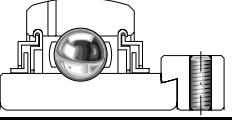
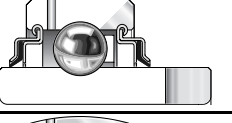
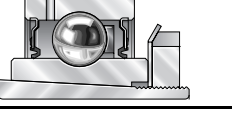
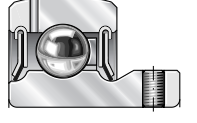
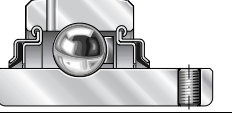
							
		GG ASE d = 12 a 120	GG SAO d = 30 a 100 serie pesada	GG SHE d = 12 a 60	GG LCTE d = 12 a 40 sin agujero de engrase	GG GLCTE d = 12 a 40	
	RAE..NPPB d = 12 a 50 (sin 45) sin agujeros de engrase					FLCTE d = 12 a 40	
	GRAE..NPPB d = 12 a 60		PASE d = 12 a 60		PSHE d = 12 a 60		GLCTE d = 12 a 40
	GE..KRRB d = 17 a 120		RASE d = 17 a 120		RSHE d = 17 a 60		
	GNE..KRRB d = 30 a 100 serie pesada			RSAO d = 30 a 100			
	GE..KPPB-3 d = 20 a 80 con obturaciones de 3 labios		TASE d = 20 a 80		TSHE d = 20 a 60		
	GE..KLLHB d = 20 a 50 con obturaciones de laberinto		LASE d = 20 a 50		LSHE Sobre consulta		
	GLE..KRRB d = 20 a 70 rodamientos libres		RASEL d = 20 a 70				
	GSH..RRB d = 20 a 50 rodamientos con manguitos de fijación		RASEA d = 20 a 40		RSHEA Sobre consulta		
	AY..NPPB d = 12 a 30 sin agujeros de engrase					FLCTEY d = 12 a 30	
	GAY..NPPB d = 12 a 60		PASEY d = 12 a 60		PSHEY d = 12 a 60	FLCTEY d = 35 a 40	GLCTEY Sobre consulta
	GYE..KRRB d = 12 a 90		RASEY d = 12 a 90		RSHEY d = 15 a 60		

Programa estándar

Las demás referencias muestran otras posibilidades de combinación.
Suministro sobre consulta.

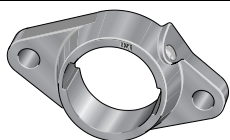

GG CJT d = 12 a 75	GG CJTZ d = 20 a 60 con resalte de centrado	GG CFT d = 12 a 50 altura menor que CJT
------------------------------	---	---

GG ME d = 20 a 120	GG MEO d = 30 a 100 serie pesada
------------------------------	---

GG FE d = 25 a 60

GG CJ d = 12 a 120	GG CJO d = 30 a 100 serie pesada	GG CF d = 20 a 50 altura menor que CJT
------------------------------	---	--

PCJT d = 12 a 60		PCFT d = 12 a 50
RCJT d = 17 a 75	RCJTZ d = 20 a 60	
TCJT d = 20 a 75		
LCJT d = 20 a 50		
RCJTL Sobre consulta		
RCJTA d = 20 a 40		
PCJTY d = 12 a 60		PCFTY Sobre consulta
RCJTY d = 12 a 75		

PME d = 20 a 60	
RME d = 20 a 120	
	RMEO d = 30 a 100
TME d = 20 a 80	
LME Sobre consulta	
RMEL Sobre consulta	
RMEA Sobre consulta	
PMEY d = 20 a 60	
RMEY d = 20 a 90	

RFE d = 25 a 60
TFE d = 25 a 60

PCJ d = 12 a 60		PCF d = 20 a 50
RCJ d = 17 a 120		
	RCJO d = 30 a 100	
TCJ d = 20 a 80		
RCJL d = 30 a 70		
RCJA Sobre consulta		
PCJY d = 12 a 60		
RCJY d = 12 a 90		

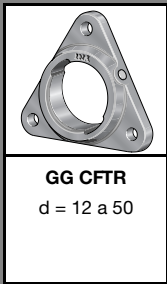

GG CFTR
d = 12 a 50



GG TUE
d = 20 a 120

GG TUEO
d = 80 a 100
serie pesada

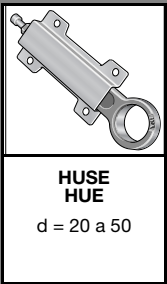

**HUSE
HUE**
d = 20 a 50



GG HE
d = 20 a 50

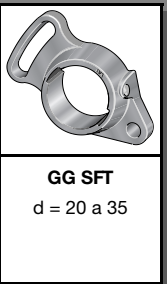

GG SFT
d = 20 a 35

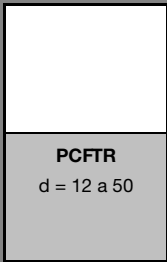
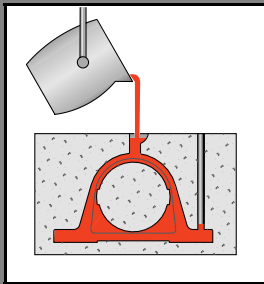

PCFTR
d = 12 a 50

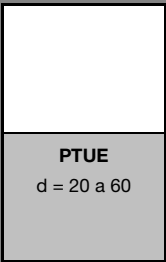

PTUE
d = 20 a 60

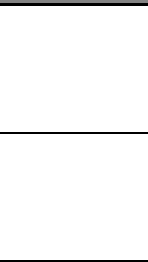

RTUE
d = 20 a 120

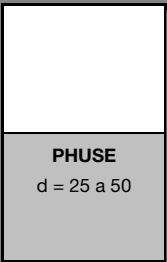

PHUSE
d = 25 a 50

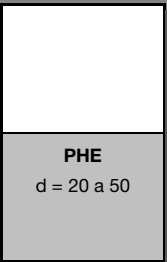

PHE
d = 20 a 50

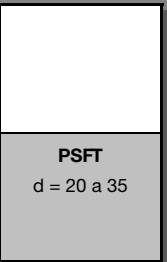

PSFT
d = 20 a 35

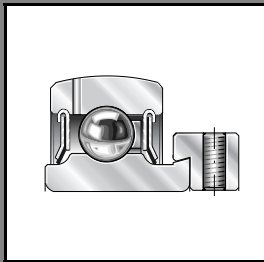

RTUEO
d = 80 a 100

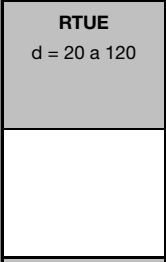

TTUE
d = 20 a 80

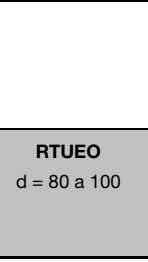

RTUEL
Sobre consulta

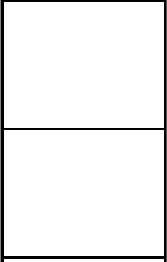

THE
d = 20 a 50

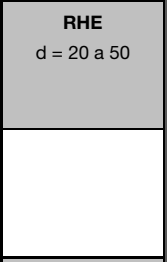

RHE
d = 20 a 50

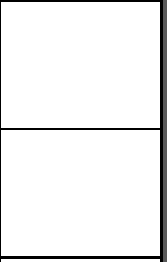

PHEY
d = 20 a 45

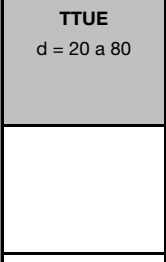
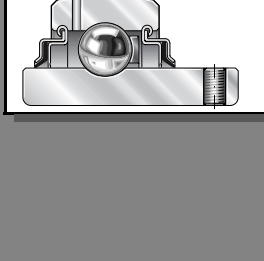
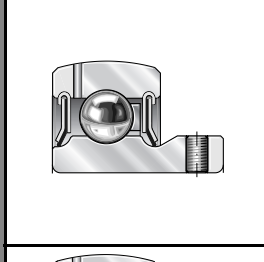
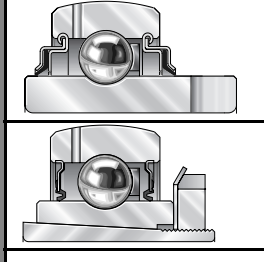
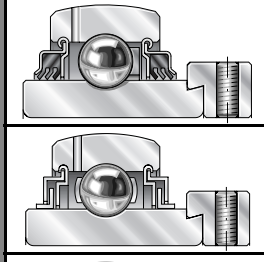
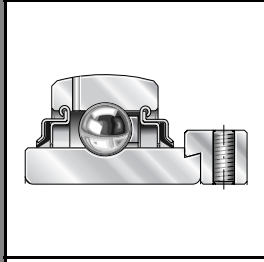

PTUEY
d = 20 a 60

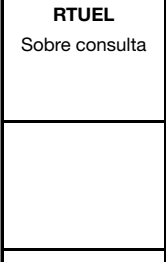

RTUEY
d = 20 a 80

Rodamientos autoalineables con soportes de chapa de acero

	<p>GEH PBS d = 12 a 40</p>	<p>GEH BT d = 12 a 30</p>	<p>GEH BT GRG d = 12 a 30</p>	<p>LST (2 piezas) d = 20, 25</p> <p>MST (2 piezas) d = 12 a 40</p>		
	<p>RALE..NPPB d = 20 a 30 serie ligera, sin agujeros de engrase</p>			<p>RPB d = 30</p>	<p>RALT d = 20, 25</p>	
	<p>RAE..NPPB d = 12 a 50 (sin 45) sin agujeros de engrase</p>	<p>PBS d = 12 a 40</p>	<p>PB d = 12 a 30</p>	<p>RPB d = 12 a 25</p>		<p>RAT d = 12 a 40</p>
	<p>GRAE..NPPB d = 12 a 60</p>					
	<p>GE..KRRB d = 17 a 120</p>	<p>RBS d = 17 a 40</p>	<p>RB d = 17 a 30</p>			<p>RRT d = 17 a 40</p>
	<p>GE..KPPB-3 d = 20 a 80 con obturaciones de 3 labios</p>	<p>TBS d = 20 a 40</p>	<p>TB d = 20 a 30</p>			<p>RTT d = 20 a 40</p>
	<p>GE..KLLHB d = 20 a 50 con obturaciones de laberinto</p>	<p>LBS d = 20 a 40</p>	<p>LB d = 20 a 30</p>			<p>RLT d = 20 a 40</p>
	<p>GLE..KRRB d = 20 a 70 rodamientos libres</p>	<p>RBSL d = 20 a 40</p>	<p>RBL d = 20 a 30</p>			<p>RRTL d = 20 a 40</p>
	<p>GSH..RRB d = 20 a 50 rodamientos con manguitos de fijación</p>	<p>RBSA d = 20 a 40</p>	<p>RBA d = 20 a 30</p>			<p>RRTA d = 20 a 40</p>
	<p>AY..NPPB d = 12 a 30 sin agujeros de engrase</p>	<p>PBSY d = 12 a 30</p>	<p>PBY d = 12 a 30</p>			<p>RATY d = 12 a 30</p>
	<p>GAY..NPPB d = 12 a 60</p>	<p>PBSY d = 35 a 40</p>				<p>RATY d = 35 a 40</p>
	<p>GYE..KRRB d = 12 a 90</p>	<p>RBSY d = 12 a 40</p>	<p>RBY d = 12 a 30</p>			<p>RRTY d = 12 a 40</p>

Programa estándar

Para las demás referencias los soportes y los rodamientos deben pedirse por separado y se suministran también por separado.

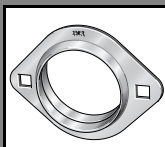

**CSLT
CST**
d = 20 a 30



**RCSMF
GRG**
d = 12 a 30



MSB
(2 piezas)
d = 12 a 60

**MSA
MSB**
d = 20 a 50
reengrasables

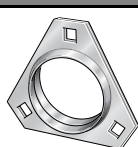

LSTR
(2 piezas)
d = 20 a 30
serie ligera

MSTR
(2 piezas)
d = 20 a 35

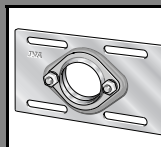

**GEH
MSTU**
d = 25 a 30

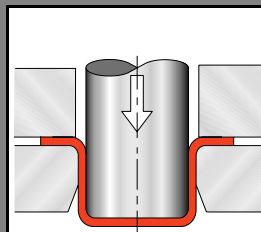

PCSLT
d = 20 a 30

RCSMF
d = 12 a 30

RA
d = 12 a 40

GRA
d = 20 a 50

RALTR
d = 20 a 30

RATR
d = 20 a 35

MSTU
d = 25 a 30

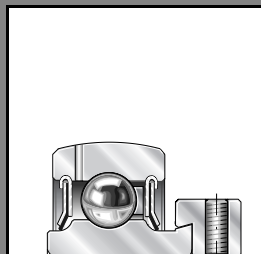

RA
d = 45 a 60

GRA
d = 20 a 50

RR
d = 17 a 60

GRR
d = 20 a 50

TR
d = 20 a 60

GTR
d = 20 a 50

LR
d = 20 a 50

GLR
d = 20 a 50

RRL
d = 20 a 60

GRRL
d = 20 a 50

RRA
d = 20 a 40

GRRRA
d = 20 a 40

RAY
d = 12 a 30

GRAY
d = 20 a 50

RAY
d = 35 a 60

GRAY
d = 20 a 50

RRY
d = 12 a 60

GRRY
d = 20 a 50

RRTR
d = 20 a 35

RTTR
d = 20 a 35

RLTR
d = 20 a 35

RRTRL
d = 20 a 35

RRTRA
d = 20 a 35

RATRY
d = 20 a 30

RATRY
d = 35

RRTRY
d = 20 a 35

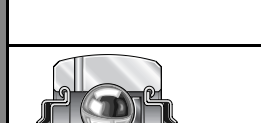
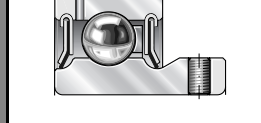
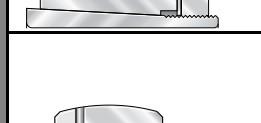
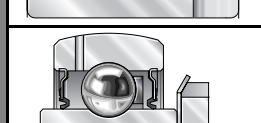
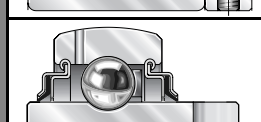
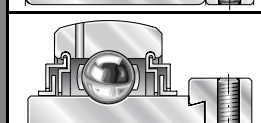
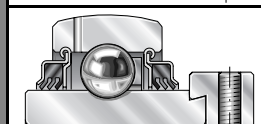
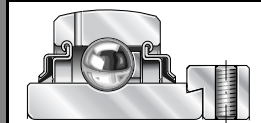

Soportes de fundición protegidos contra la corrosión

Rodamientos

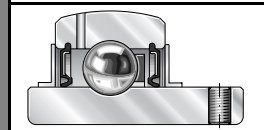
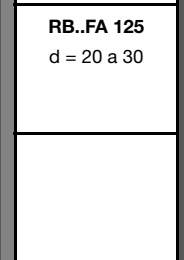
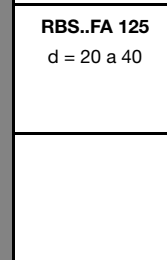
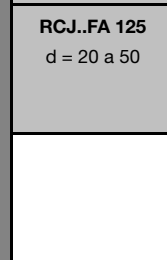
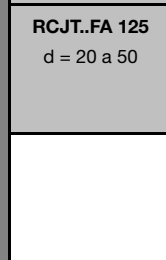
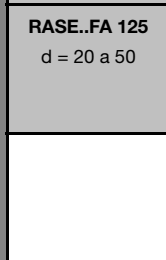
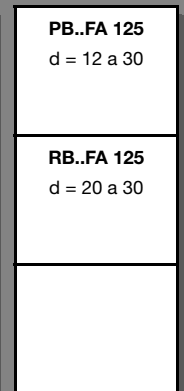
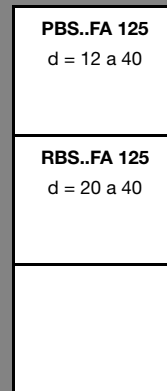
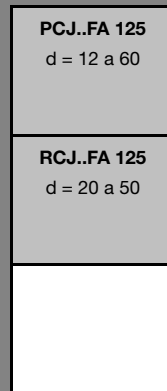
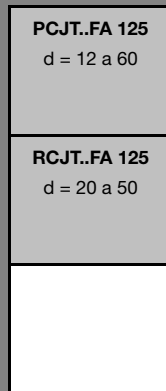
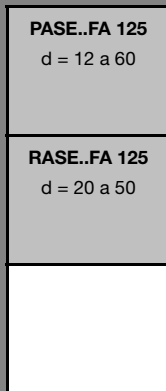
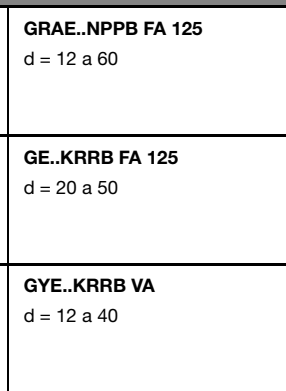
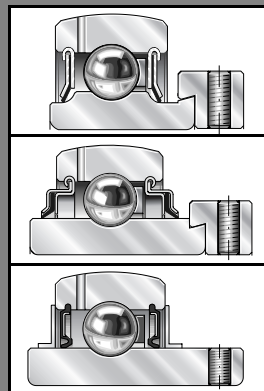
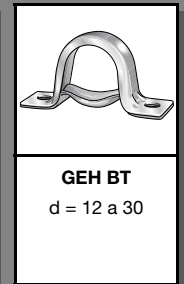
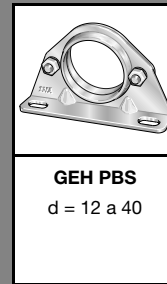
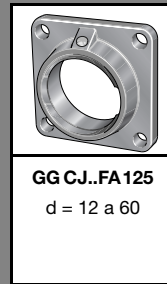
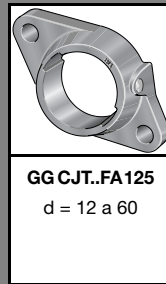
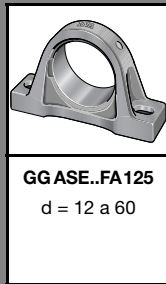
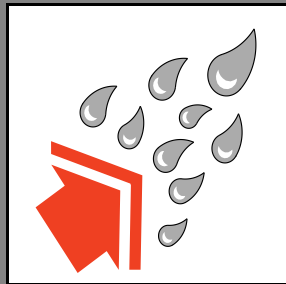



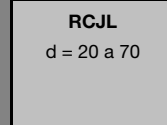
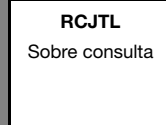
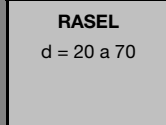
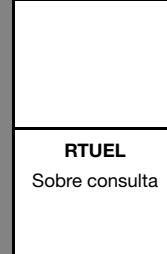
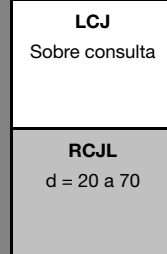
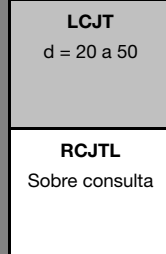
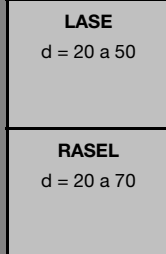
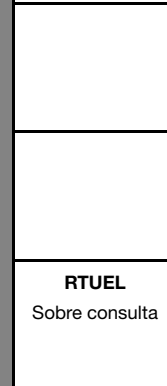
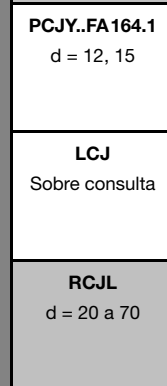
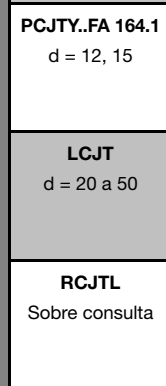
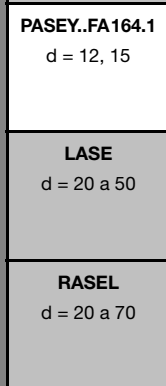
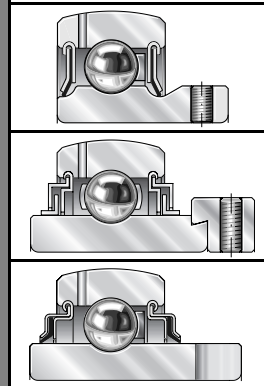
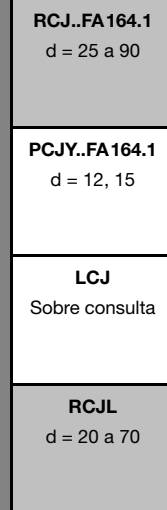
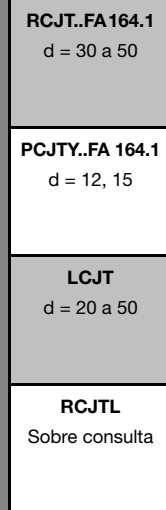
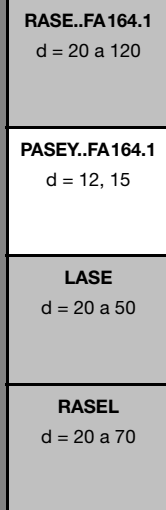
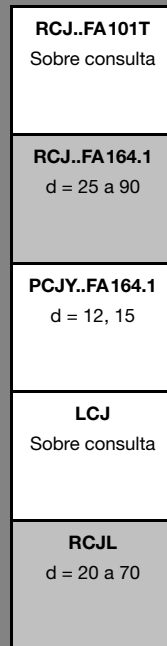
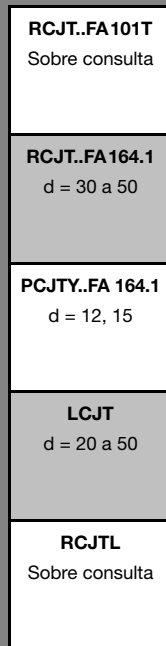
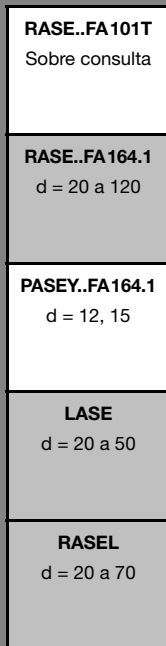
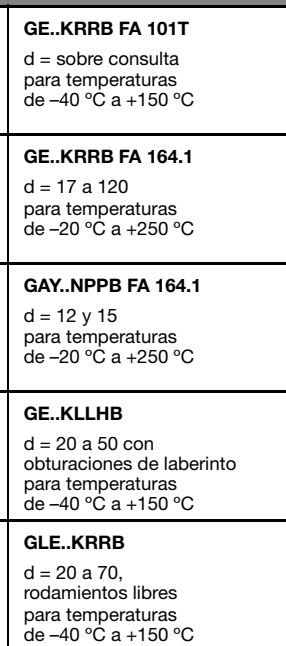
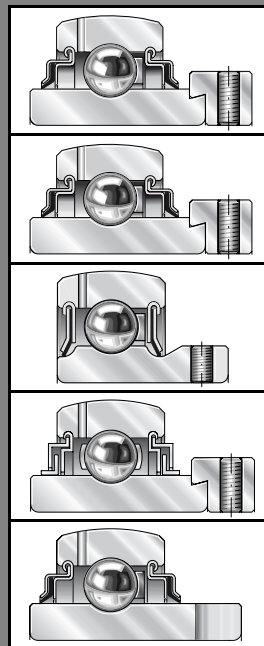
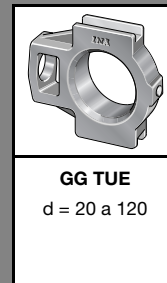
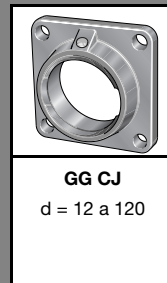
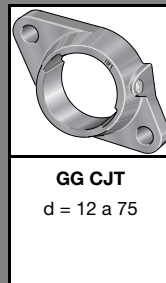
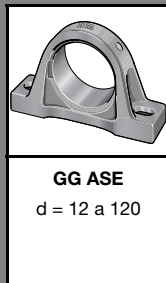
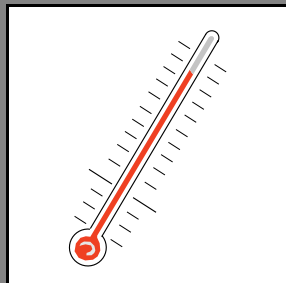

Soportes de fundición para altas temperaturas



Programa estándar

autoalineables y soportes de chapa de acero

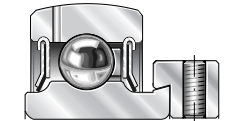
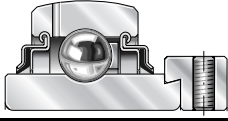
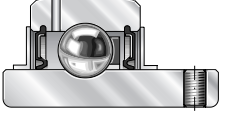
					
MST..FA 125 (2 piezas) d = 12 a 40	MSB..FA 125 (2 piezas) d = 12 a 60	MSA..FA 125 MSB..FA 125 d = 20 a 50 reengrasables	MSTR..FA 125 d = 20 a 35		MSB..VA (2 piezas) d = 12 a 30
RAT..FA 125 d = 12 a 40	RA..FA 125 d = 12 a 60	GRA..FA 125 d = 20 a 50	RATR..FA 125 d = 20 a 35		
RRT..FA 125 d = 20 a 40	RR..FA 125 d = 20 a 50	GRR..FA 125 d = 20 a 50	RRTR..FA 125 d = 20 a 35		
					
				RRY..VA d = 12 a 30	GRRY..VA d = 20 a 30

Los soportes de chapa de acero y los rodamientos deben pedirse por separado y se suministran también por separado.

FA 125 = Recubrimiento especial Corrotect® de INA (recubrimiento de cinc-hierro-cobalto).

VA = Acero inoxidable.

Tapas de protección

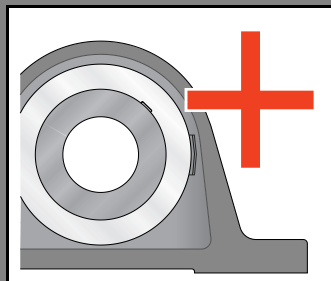

INA puede suministrar, como accesorio, tapas de protección de plástico para cubrir los extremos libres de los ejes:

- así se asegura la protección contra accidentes cuando el eje está en rotación
- protección adicional contra la entrada de suciedad o impurezas.

Las tapas de protección están disponibles para:

- los soportes autoalineables PASE..., PASE..FA125, RASE..., RASE..FA125, PSHE..., RSHE..., PCJT..., PCJT..FA125, RCJT..., RCJT..FA125, PME..., RME..., PCJ..., PCJ..FA125, RCJ..., RCJ..FA125 con diámetro de eje de 20, 25, 30, 35, 40, 50 y 60 mm.
- Otros soportes, sobre consulta

Los soportes disponen de una ranura para la fijación de las tapas de protección situada en el lado del anillo tensor excéntrico.

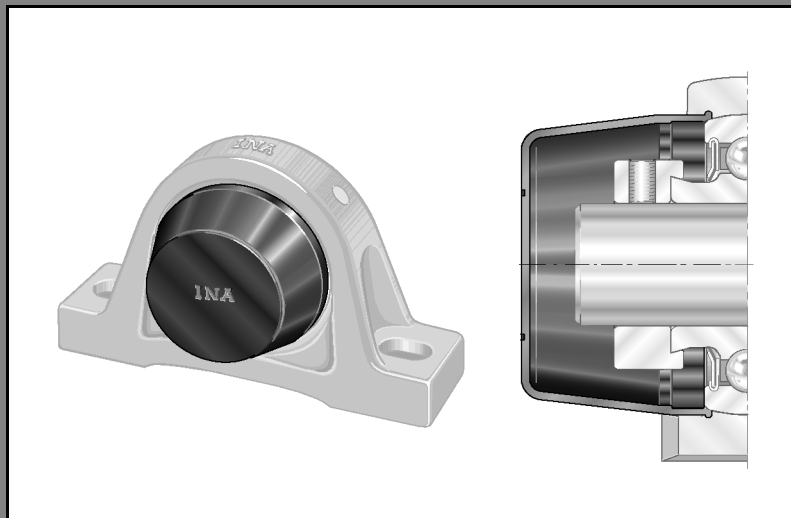
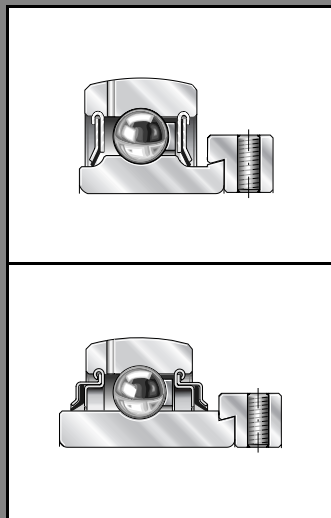

Características y selección de los soportes autoalineables

Los soportes autoalineables INA son elementos de máquina robustos, listos para el montaje y fáciles de montar. Permiten sistemas de apoyo fiables y económicos que funcionan perfectamente tanto en condiciones de utilización normales como en ambientes húmedos o con fuerte suciedad.

Estas unidades, que son apreciadas ya desde hace tiempo, se suministran en varias series y se componen de forma estándar de:

- soportes de apoyo o soportes-brida y
- rodamientos autoalineables engrasados y obturados por ambos lados.

Soportes de fundición gris o de chapa de acero

Los soportes son de fundición gris o de chapa de acero.

Los soportes de fundición gris son de una sola pieza, soportan elevadas cargas y disponen de un agujero roscado para fijar un engrasador para lubricar los rodamientos autoalineables. Los soportes de chapa embutida son en dos piezas y soportan cargas medias.

Rodamientos autoalineables

Los rodamientos autoalineables tienen un anillo exterior con superficie externa esférica adaptada al agujero del soporte,

anillos interiores alargados por uno o por ambos lados y obturaciones rozantes o sin rozamiento. Estos rodamientos se fijan radialmente al eje mediante un anillo tensor excéntrico o por dos tornillos prisioneros del anillo interior.

Compensación de errores de alineación

La ejecución específica del anillo exterior del rodamiento y del agujero esférico del soporte permite al anillo exterior posicionarse para compensar errores de alineación del eje. De esta forma se compensan las desviaciones del eje ocasionadas por imprecisiones en el montaje o por tolerancias de las construcciones anexas.

Soportes para aplicaciones especiales

Además de las ejecuciones para aplicaciones estándar, INA puede suministrar soportes para elevadas temperaturas o con protección antioxidante.



Catálogo INA "Rodamientos autoalineables y soportes"

Este catálogo describe el programa completo de INA para estos soportes y rodamientos autoalineables. Además aporta información sobre otros productos INA, como las poleas tensoras y las ruedas tensoras de cadenas.

Rodamientos autoalineables combinados con

Para seleccionar un soporte:

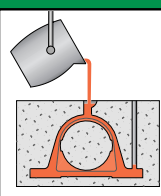
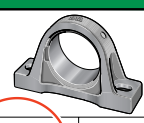
- ① Definir el cuerpo soporte
- ② Definir el rodamiento
- ③ Determinar la combinación con ayuda de la tabla
 - La zona sombreada indica el soporte del programa estándar

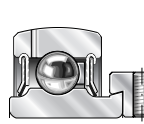
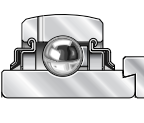
						
			GG ASE d = 12 a 120 ①	GG SAO d = 30 a 100 Serie pesada	GG SHE d = 12 a 60	
			RAE..NPPB d = 12 a 50 (excepto 45) Sin agujeros de reengrase	PASE d = 12 a 60 ③		PSHE d = 12 a 60
			GRAE..NPPB d = 12 a 60 ②	GE..KRRB d = 17 a 120	RASE d = 17 a 120	RSHE d = 17 a 60
			GNE..KRRB d = 30 a 100 Serie pesada	RSOA d = 30 a 100		
			GE..KPPB	GG..SAO		



INA Rodamientos, s.a.

Polígono Pont Reixat
08960 Sant Just Desvern · Barcelona
Teléfono (93) 480 34 10 · Fax (93) 372 92 50
E-mail: marketing@es.ina.com
www.inarodamientos.es